

CLO®

LIVING BOARD

LE LAVAGNE MAGNETICHE IN VETRO
Made in Italy

GLASS MAGNETIC BOARDS
Made in Italy

Delka

SCRIVI

SCRIVI E RISCRIVI
SENZA SPORCARE

Scrivi tutte le tue idee in un attimo sulla lavagna in vetro. Puoi usare la lavagna all'infinito per i tuoi appunti senza mai sporcare. Con il pennarello non fai polvere e con il cancellino togli tutto e non lasci traccia.

WRITE AND REWRITE
WITH ONE GENTLE WIPE

Write all your ideas in a moment on a glass writing board. Note down on the board and wipe it clean, endlessly.

CANCELLA



CLO.GLASS.IT



ATTACCA



Magnetico



TANTI MAGNETI
PER ATTACCARE
CIÒ CHE VUOI

Le lavagne in vetro CLO sono magnetiche. Attacca pure tutti i promemoria che vuoi e i foglietti da tenere in bella vista con le calamite in legno naturale, nessun appuntamento ti volerà più via.

LOTS OF MAGNETS TO
ATTACH WHATEVER YOU
WANT

The CLO glass writing boards are magnetic. Stick all your reminders and leaflets in plain view with the magnets in natural wood, you'll never miss an appointment again.

FIX THE
MOMENT

ART IS THE
DAUGHTER
OF FREEDOM.

FRIEDRICH SCHILLER







FACILE

Montaggio semplice, rapido e sicuro grazie al gancio brevettato.

EASY

Easy installation and fast, it's safe thanks to the patented hook.



PROVATA

Rispetta le normative **EN 14434:2010**
Ha i requisiti per le forniture scolastiche di ogni ordine e grado.

PROVEN

According to **EN 14434:2010**
It has all the requirements for school supplies of any types and levels.



RESISTENTE

Angoli arrotondati, spigoli smussati, vetro temperato, fissaggio e incollaggio sicuro.

DURABLE

Rounded corners and edges, tempered glass, safe and secure assembling and fixing.



ECOSOSTENIBILE

Realizzata con materiali riciclabili.

ECOLOGICALLY SUSTAINABLE

Made with recycled materials.

PRODOTTO TESTATO NEI LABORATORI CATAS
Rapporto di prova n° 219785 - 219824 - 219866



TESTED BY CATAS LABORATORY
Certification n° 219785 - 219824 - 219866

CATAS è l'istituto per la certificazione, ricerca e prove nel settore legno-arredo.
CATAS is the Italian research and certification institute and test laboratory in the wood and furniture field.

SEMPLICE DA MONTARE CON AGGANCO BREVETTATO

Le lavagne CLO si montano rapidamente
con tre semplici passaggi.
Grazie al nostro aggancio brevettato,
una volta fissate restano
ancorate in modo stabile e sicuro.

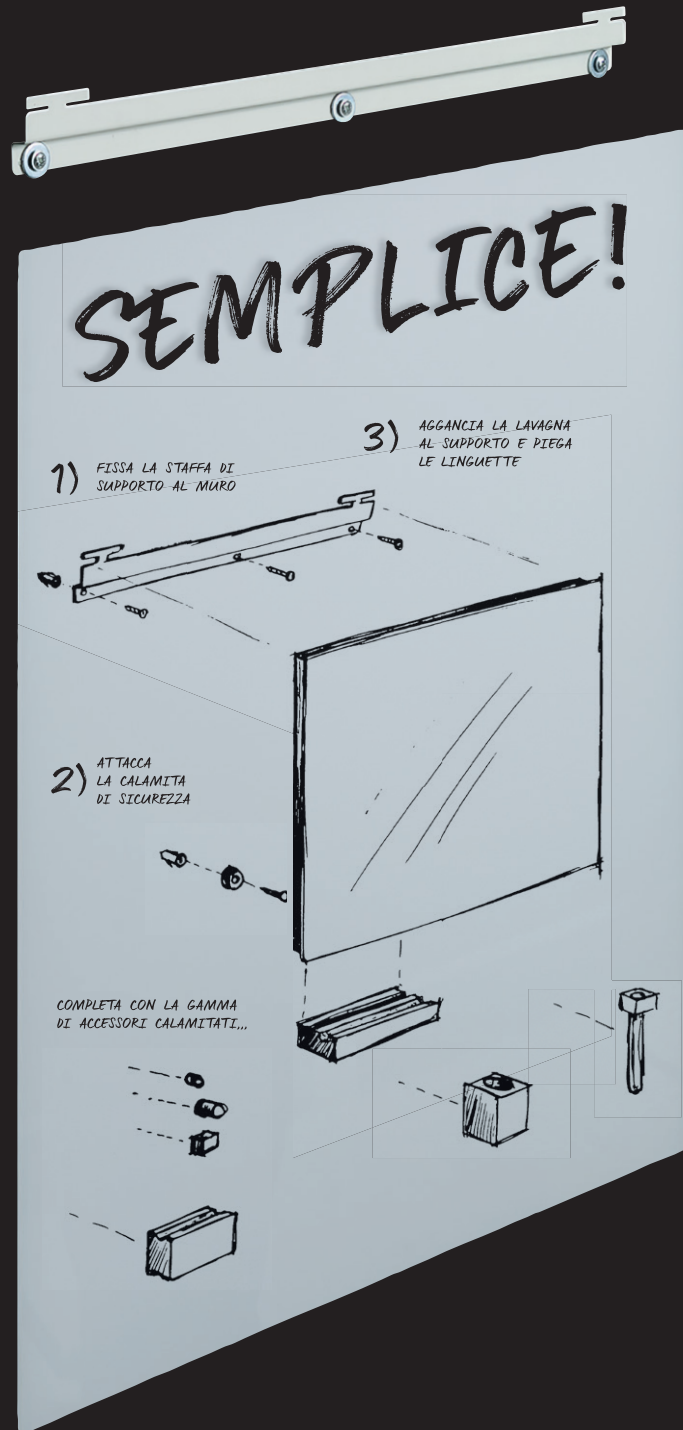

EASILY ASSEMBLABLE WITH PATENTED FASTENING SYSTEM

CLO boards are very quick to
assemble in three simple steps.
Once hung and fixed on walls stability
and safety are both ensured thanks
to a certified fastening system.



GLO
LIVING - BOARD



GLO
LIVING BOARD



PERFETTO
PER TUTTI
GLI AMBIENTI

IDEAL FOR
ANY TYPE OF
ENVIRONMENT





0

1

START GROWTH !!! +\$

1990 2000 2010 2020 2050

TIMELINE

WINTER SPRING SUMMER

H KY

QD GLASS II QD GLASS II



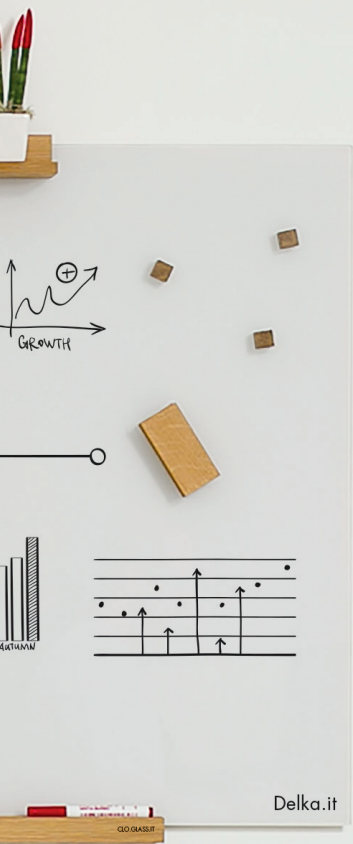

Planning

PRESENTA LE TUE IDEE

In ufficio, nelle sale riunioni oppure nelle aule, le lavagne CLO sono perfette per esporre concetti, disegnare diagrammi e annotare gli sviluppi di un processo lavorativo.

TO EXPRESS YOUR IDEAS

In an office, meeting rooms, classrooms, CLO writing boards are perfect to slide concepts, draw diagrams and record any development of working progress.

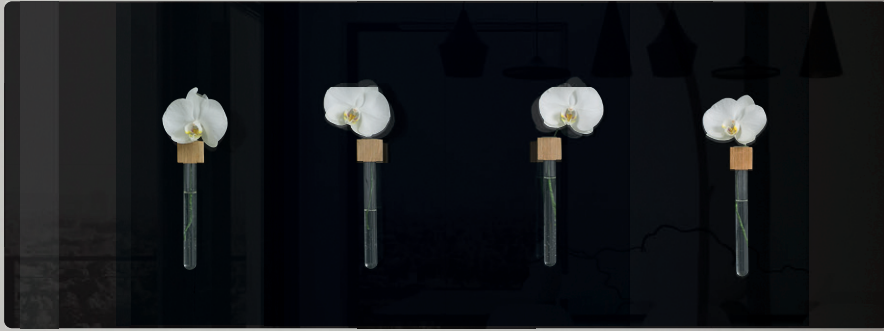

GLO
LIVING BOARD

DAI UN TOCCO DI STILE

Usa le lavagne per arredare i tuoi spazi, decorale con elementi tridimensionali o personalizza la stanza con una lavagna che sembra un quadro.

GIVE A TOUCH OF STYLE

Use the writing board to furnish your space either decorating it with 3D elements or making it look like a real painting.

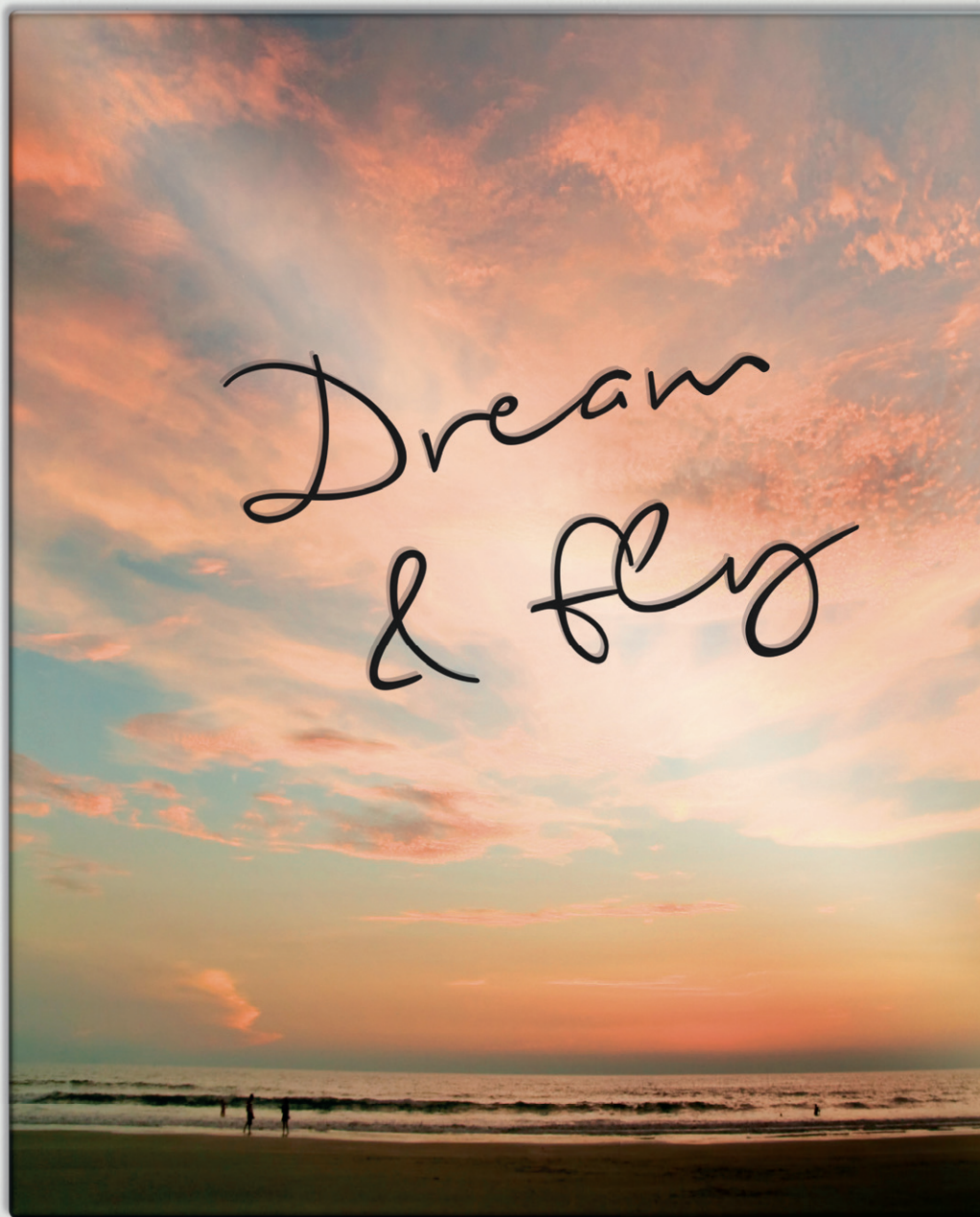



GLO

LIVING BOARD

ORGANIZZA LE TUE GIORNATE

Usa le lavagne tutti i giorni per controllare con un colpo d'occhio gli impegni e le scadenze della vita quotidiana.

ORGANIZING YOUR DAY

Use the writing board daily to check in a quick glance your appointments and deadlines.





GLO
LIVING BOARD

RACCONTA

LE TUE PASSIONI

Colleziona la tua storia, scrivi le frasi che ti emozionano, conserva e metti in cornice biglietti, cartoline e foto che compongono i tuoi ricordi più belli.

RELATE YOUR PASSIONS

Gather your stories, write phrases that touched you, preserve and put in frame tickets, postcards and photos that put together your most beautiful memories.

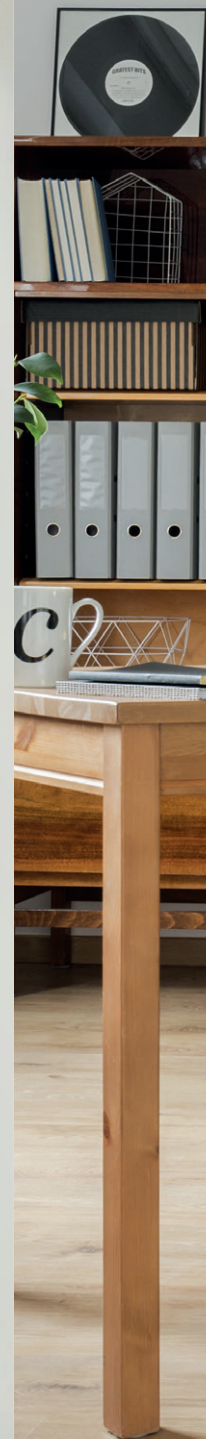



WENT OUTSIDE
AND SAW THE MOON
AND IT MADE ME
THINK OF YOU.

I love
you ♥

Make
Today
amazing



nothing would
have
come easy



la route
nous
rend
libres



CLO GLASS





SKY



GLO

LIVING BOARD

DECORA CON FANTASIA

Scegli uno dei nostri modelli per arredare con un tocco d'arte i tuoi spazi. Con le lavagne che si ispirano alle stagioni e al cielo avrai una finestra sul mondo.

DECORATE WITH FANTASY

Choose among one of our models to furnish with a touch of art your spaces. With those inspired to the seasons or the skies above, you will have a window on the world.



AUTUMN



SUMMER



WINTER



SPRING

GLO
LIVING BOARD

80 X 200

E6





E1



E3



E2



E4



E5

COMBINA TRA LORO I FORMATI

Le lavagne CLO sono disponibili in più formati.
Puoi sceglierne uno, oppure combinarli tra loro
creando delle vere e proprie composizioni da parete,
sia in verticale che orizzontale.

COMBINE BETWEEN THEIR SIZE OPTIONS

The CLO boards are available in multiple formats.
You can choose one or combine them together
to create true wall compositions, hanging and
turning them in any directions.



E7



GLO
LIVING - BOARD





ACCESSORI CALAMITATI

Completa la tua lavagna con gli accessori calamitati della linea CLO. Oggetti di design realizzati in legno naturale e pensati per rendere ancora più funzionale e pratica le lavagne magnetiche.

MAGNETIC ACCESSORIES

Complete your writing board with magnetic CLO accessories made of natural wood. These objects are designed to make it even more functional and practical.



MENSOLE INFERIORI LOWER SHELVES

ART.	SIZES
MEIN20	5 x 20
MEIN40	5 x 40



MENSOLE SUPERIORI UPPER SHELVES

ART.	SIZES
MESU7	7 x 7
MESU15	7 x 15
MESU22	7 x 22

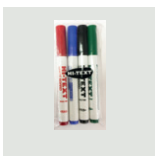

PENNARELLI MARKER PEN

ART.	SIZES
MAKERS	4 PZ



CANCELLINO DUSTER

ART.	SIZES
CANC1	5 x 10

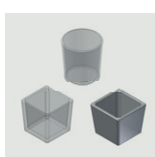

VASI / VASE HOLDER

ART.	SIZES
VATON	6 x 6
VAQUA	6 x 6
CERAMIC	6 x 6



PORTAPENNE DA TAVOLO TABLE PEN HOLDER

ART.	SIZES
PENHOLDER	8 x 8 x 18

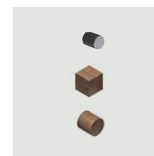

CALAMITE/MAGNETIC

ART.	SIZES
PURE	1 x 1,2
SQUARE	2 x 2
CIRCLE	2 x 2



PORTAFIORI/PENNE CON VASO IN VETRO FLOWER VASE/PENS

ART.	SIZES
CUBE	8 x 8 x 8

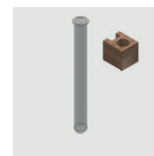

FIALA PORTAFIORI FLOWER PHIAL

ART.	SIZES
PHIAL	2 x 18

COLLECTION COLOUR

BIANCO NEVE
SNOW WHITE

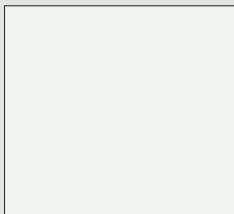

NERO
BLACK



GRIGIO
GREY



BIANCO PERLA
PEARL WHITE



ART.	SIZES
E1BIN	50 x 50
E2BIN	50 x 80
E3BIN	50 x 120
E4BIN	80 x 20
E5BIN	80 x 120
E6BIN	80 x 200
E7BIN	98 x 98

ART.	SIZES
E1NER	50 x 50
E2NER	50 x 80
E3NER	50 x 120
E4NER	80 x 20
E5NER	80 x 120
E6NER	80 x 200
E7NER	98 x 98

ART.	SIZES
E1GRI	50 x 50
E2GRI	50 x 80
E3GRI	50 x 120
E4GRI	80 x 20
E5GRI	80 x 120
E6GRI	80 x 200
E7GRI	98 x 98

ART.	SIZES
E1BIP	50 x 50
E2BIP	50 x 80
E3BIP	50 x 120
E4BIP	80 x 20
E5BIP	80 x 120
E6BIP	80 x 200
E7BIP	98 x 98

COLLECTION PRINT

SKY

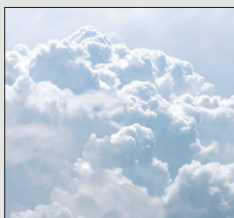

AUTUMN

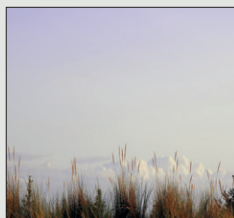

WINTER

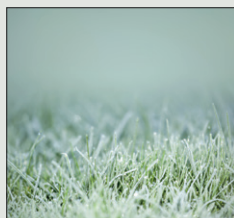

SPRING



SUMMER

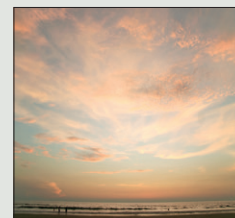

ART.	SIZES
E1SKY	50 x 50
E2SKY	50 x 80
E3SKY	50 x 120

ART.	SIZES
E1AUT	50 x 50

ART.	SIZES
E1WIN	50 x 50

ART.	SIZES
E1SPR	50 x 50

ART.	SIZES
E1SUM	50 x 50

CAPPUCCINO
CAPPUCCINO

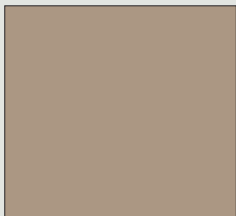

ROSSO
RED



VERDE PISTACCHIO
PISTACHIO GREEN

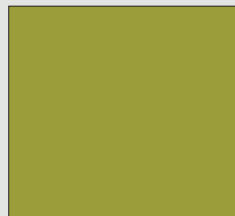

AZZURRO
BLUE

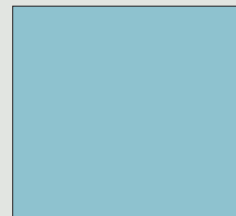

ART.	SIZES
E1CAP	50 x 50
E2CAP	50 x 80
E3CAP	50 x 120
E4CAP	80 x 20
E5CAP	80 x 120
E6CAP	80 x 200
E7CAP	98 x 98

ART.	SIZES
E1ROS	50 x 50
E2ROS	50 x 80
E3ROS	50 x 120
E4ROS	80 x 20
E5ROS	80 x 120
E6ROS	80 x 200
E7ROS	98 x 98

ART.	SIZES
E1VEP	50 x 50
E2VEP	50 x 80
E3VEP	50 x 120
E4VEP	80 x 20
E5VEP	80 x 120
E6VEP	80 x 200
E7VEP	98 x 98

ART.	SIZES
E1AZZ	50 x 50
E2AZZ	50 x 80
E3AZZ	50 x 120
E4AZZ	80 x 20
E5AZZ	80 x 120
E6AZZ	80 x 200
E7AZZ	98 x 98

PACKAGING



CONTENUTO CONFEZIONE:	PACKAGE CONTENTS:
Lavagna magnetica in vetro	Glass magnetic board
Kit staffa con viti	Kit brackets with screws
Due magneti Pure	Two Pure magnets
Libretto istruzioni	User's manual

CLO
LIVING BOARD



CLO

LIVING BOARD

 **Delka**

CLO by Delka S.r.l.
Via Crevada, 63
31020 Refrontolo (TV)
Tel +39 0438 435535
Fax +39 0438 439798
www.delka.it/delka/
info@delka.it