

Delka



ARCA

Strutture Tavoli
Desk Structures

Semplicità modulare

Una postazione che risponde con performante semplicità alle esigenze di spazi lavorativi differenti. Linee pulite create da elementi modulari che si compongono e danno vita a soluzioni strutturate dove screen divisori, cassettiere si integrano con i tavoli e danno vita a spazi funzionali e armoniosi.

Modular Simplicity

A workstation that responds with performing simplicity to the needs of different working spaces. Clean lines, created by modular elements that compose and give life to structured solutions where screen dividers, drawers, integrate with tables, and give life to functional and harmonious spaces.



ARCA

Strutture Tavoli / Desk Structures



ARCA

Strutture Tavoli / Desk Structures





ARCA

Strutture Tavoli / Desk Structures

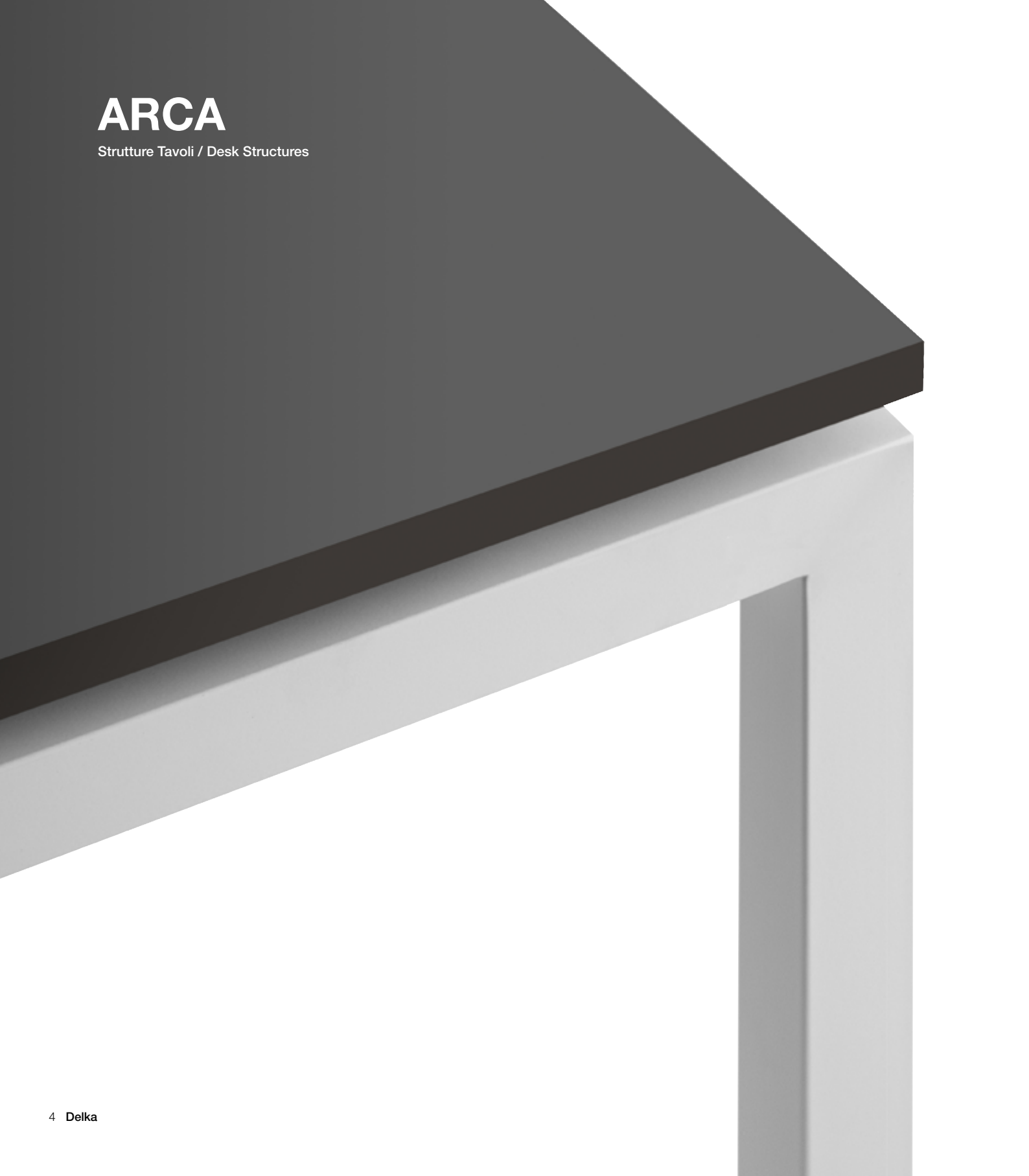



Passacavi rettangolare
Top access with flap



Passacavi rotondo
Round grommet



Top access con sportello apribile e vasca cablaggio
Top access with swivel flap and cable managing support



Vassoio passacavi per bench
Cable support for bench



Passaggio cavi
Cable management



Piedini livellatori
Adjustable feet

ARCA

Strutture Tavoli / Desk Structures

EASY-LINK SYSTEM

Strutture in metallo per tavoli disponibili
con altezza fissa o regolabile.

Metal structures for desks available
with static or adjustable height.

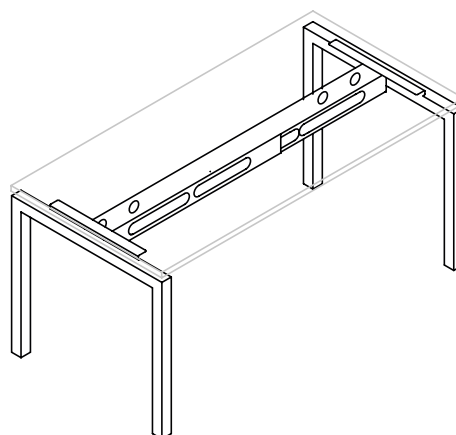
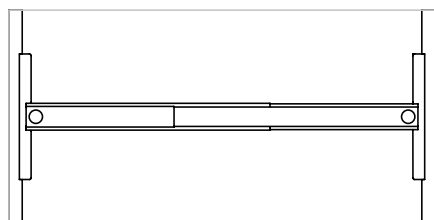
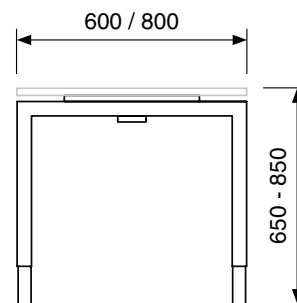
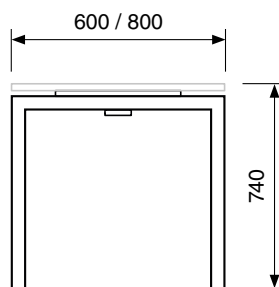
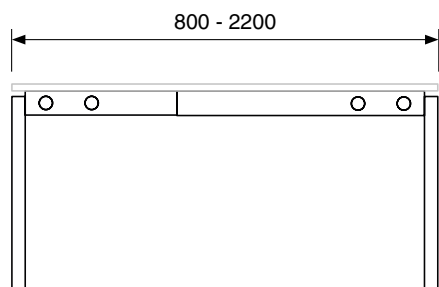

COLORI STRUTTURE / METAL COLOR



Antracite
Anthracite
8301



Bianco opaco
Matt White
9010



Grigio opaco
Matt Grey
7022



Nero
Black
9005



Bianco lucido
Gloss White
9010



HJT
9006



Grigio grafite
Graphite grey
7024

ARCA COLLECTION

TAVOLI ALTEZZA FISSA Z (F) O REGOLABILE Z (R)
 WORKSTATIONS STATIC Z (F) OR ADJUSTABLE HEIGHT Z (R)
 TABLES BUREAU FIXES Z (F) OU RÉGLABLES EN HAUTEUR Z (R)
 MESAS ALTURA FIJA Z (F) O AJUSTABLE Z (R)

X	Y	Z (F)	Z (R)
800	800	740	650/850
1000	800	740	650/850
1200	800	740	650/850
1400	800	740	650/850
1600	800	740	650/850
1800	800	740	650/850
2000	800	740	650/850
2200	800	740	650/850
800	600	740	650/850
1000	600	740	650/850
1200	600	740	650/850

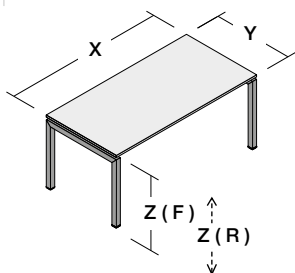

ACCESSORI SU RICHIESTA / EXTRA ACCESSORIES / ACCESSOIRES SUR DEMANDE / ACCESORIOS OPCIONAL

GONNE MODESTY PANELS VOILES DE FOND FALDONES	PANNELLI SCREEN SCREEN PANELS ÉCRAN DE SEPARATION PANELES SEPARADOR	GESTIONE CAVI CABLE MANAGEMENT GESTION DE CABLE GESTION DE CABLES	PORTA CPU REGOLABILE ADJUSTABLE CPU HOLDER SUPPORT UC RÉGLABLE SOPORTE CPU AJUSTABLE																																																																																														
<table border="1"> <thead> <tr><th>X</th><th>Z</th></tr> </thead> <tbody> <tr><td>1200</td><td>350</td></tr> <tr><td>1400</td><td>350</td></tr> <tr><td>1600</td><td>350</td></tr> <tr><td>1800</td><td>350</td></tr> <tr><td>2000</td><td>350</td></tr> </tbody> </table>	X	Z	1200	350	1400	350	1600	350	1800	350	2000	350	<table border="1"> <thead> <tr><th>X</th><th>Z</th></tr> </thead> <tbody> <tr><td>600</td><td>420</td></tr> <tr><td>800</td><td>420</td></tr> </tbody> </table> <table border="1"> <thead> <tr><th>X</th><th>Y</th><th>Z</th></tr> </thead> <tbody> <tr><td>1200</td><td>18</td><td>560</td></tr> <tr><td>1400</td><td>18</td><td>560</td></tr> <tr><td>1600</td><td>18</td><td>560</td></tr> <tr><td>1800</td><td>18</td><td>560</td></tr> <tr><td>2000</td><td>18</td><td>560</td></tr> </tbody> </table> <table border="1"> <thead> <tr><th>X</th><th>Z</th></tr> </thead> <tbody> <tr><td>1000</td><td>1700</td></tr> </tbody> </table>	X	Z	600	420	800	420	X	Y	Z	1200	18	560	1400	18	560	1600	18	560	1800	18	560	2000	18	560	X	Z	1000	1700	<table border="1"> <thead> <tr><th>X</th><th>Y</th><th>Z</th></tr> </thead> <tbody> <tr><td>700</td><td>70</td><td>100</td></tr> </tbody> </table> <table border="1"> <thead> <tr><th>X</th><th>Y</th><th>Z</th><th>€</th></tr> </thead> <tbody> <tr><td>1200</td><td>280</td><td>100</td><td>28</td></tr> <tr><td>1400</td><td>280</td><td>100</td><td>30</td></tr> <tr><td>1600</td><td>280</td><td>100</td><td>33</td></tr> <tr><td>1800</td><td>280</td><td>100</td><td>36</td></tr> <tr><td>2000</td><td>280</td><td>100</td><td>40</td></tr> </tbody> </table> <table border="1"> <thead> <tr><th>X</th><th>Y</th><th>Z</th></tr> </thead> <tbody> <tr><td>230</td><td>120</td><td>18</td></tr> </tbody> </table> <table border="1"> <thead> <tr><th>X</th><th>Y</th><th>Z</th></tr> </thead> <tbody> <tr><td>430</td><td>160</td><td>100</td></tr> </tbody> </table> <table border="1"> <thead> <tr><th>X</th><th>Y</th><th>Z</th></tr> </thead> <tbody> <tr><td>350</td><td>140</td><td>140</td></tr> </tbody> </table>	X	Y	Z	700	70	100	X	Y	Z	€	1200	280	100	28	1400	280	100	30	1600	280	100	33	1800	280	100	36	2000	280	100	40	X	Y	Z	230	120	18	X	Y	Z	430	160	100	X	Y	Z	350	140	140	<table border="1"> <thead> <tr><th>X</th><th>Y</th><th>Z</th></tr> </thead> <tbody> <tr><td>240</td><td>130/215</td><td>335/535</td></tr> </tbody> </table>	X	Y	Z	240	130/215	335/535
X	Z																																																																																																
1200	350																																																																																																
1400	350																																																																																																
1600	350																																																																																																
1800	350																																																																																																
2000	350																																																																																																
X	Z																																																																																																
600	420																																																																																																
800	420																																																																																																
X	Y	Z																																																																																															
1200	18	560																																																																																															
1400	18	560																																																																																															
1600	18	560																																																																																															
1800	18	560																																																																																															
2000	18	560																																																																																															
X	Z																																																																																																
1000	1700																																																																																																
X	Y	Z																																																																																															
700	70	100																																																																																															
X	Y	Z	€																																																																																														
1200	280	100	28																																																																																														
1400	280	100	30																																																																																														
1600	280	100	33																																																																																														
1800	280	100	36																																																																																														
2000	280	100	40																																																																																														
X	Y	Z																																																																																															
230	120	18																																																																																															
X	Y	Z																																																																																															
430	160	100																																																																																															
X	Y	Z																																																																																															
350	140	140																																																																																															
X	Y	Z																																																																																															
240	130/215	335/535																																																																																															
			VERTEBRA																																																																																														



ARCA

Strutture Tavoli / Desk Structures



Progettare senza pensieri
Design with no worries



A woman with dark hair tied in a bun is shown in profile, facing right. Her eyes are closed, and her hands are clasped together over her chest. She is wearing a dark grey long-sleeved shirt. The background is a blurred natural setting with a waterfall and green foliage.

GREEN PHILOSOPHY

Alla base della "Delka Green philosophy", c'è un pensiero ecologico che oltre ad accrescere la funzionalità dei prodotti contribuisce alla diminuzione dell'inquinamento e a preservare la salute dell'utilizzatore, per creare un ambiente sano dove lavorare.

At the core of the "Delka Green philosophy" is an ecological mindset that not only enhances the functionality of products but also contributes to reducing pollution.

PRODOTTI RICICLABILI

I prodotti sono realizzati in metallo, un materiale completamente riciclabile che garantisce una durata maggiore nel tempo rispetto a molte altre materie prime.

RECYCLABLE PRODUCTS

Fully embracing the philosophy of the circular economy, our products are entirely metallic.



Delka

Crea un ambiente sano dove lavorare
Create a healthy work environment



FACILMENTE IGENIZZABILI

Lo sporco aderisce meno alle superfici in metallo dei prodotti Delka, che risultano più facili da pulire e garantiscono una maggior igienizzazione.

EASILY SANITIZABLE

Steel and iron are easy to clean and hygienic as they do not retain dirt, are resistant to the acidity of most sanitizing products, ensuring a safe and thoroughly sanitized product.

RESISTENTI AL FUOCO

La proprietà ignifuga del metallo ne fa uno dei materiali più sicuri per costruire e per realizzare prodotti con maggior esistenza al fuoco.

FIRE-RESISTANT

Thanks to the fire-resistant properties of the metal they are composed of, Delka products are safer for building and for creating products with greater resistance to fire.

VERNICI NO SOLVENT

Tutte le parti dei prodotti in metallo Delka sono verniciate con tecniche solvent free, con vernici a polvere certificate.

SOLVENT-FREE PAINTS

All metal parts of Delka products are painted using solvent-free techniques, with certified powder coatings.



DELKA 100% PRODUZIONE ITALIANA

I prodotti Delka sono il frutto di una filiera produttiva interamente italiana gestita secondo il sistema Lean Production, grazie al quale Delka garantisce la gestione di un servizio al cliente flessibile e veloce. La produzione Delka interamente gestita all'interno dell'azienda e le soluzioni tecniche innovative, sono le linee guida di un percorso di miglioramento continuo verso una direzione condivisa e sostenibile!



DELKA 100% ITALIAN PRODUCTION

Delka products are the result of an entirely Italian production chain managed according to the Lean Production system. Delka ensures the management of flexible and fast customer service. Technical-production and commercial aspects coexist at Delka, with the goal of customer satisfaction through the right balance between industrialization and component design. Delka's production is entirely managed in-house, and innovative technical solutions guide a continuous improvement journey towards a shared and sustainable direction!



Delka, sempre alla ricerca del miglioramento dei propri prodotti, si riserva la facoltà di apportare modifiche costruttive e funzionali in qualsiasi momento senza alcun preavviso.

Le immagini dei prodotti ambientati DELKA presenti in questo catalogo hanno scopo divulgativo.

Per ogni aspetto tecnico contattare direttamente l'azienda.

I campioni di colori e materiali hanno valore indicativo.

Le collezioni Delka sono protette nel mondo dal diritto di proprietà industriale e da brevetti registrati.

© Delka srl - Tutti i diritti riservati

Delka is always seeking to improve its products, the company reserves the right to modify or upgrade the products without prior notice, at any time.

All products pictures shown on this catalog are for illustration purpose.

Contact the company for any technical information.

Delka Collections are worldwide protected by the industrial property right and patents.

© Delka srl - All rights reserved.

 **Delka**

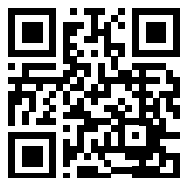

Delka S.r.l.
Via Crevada, 63
31020 Refrontolo (TV)
Tel +39 0438 435535
Fax +39 0438 439798
www.delka.it/delka/
info@delka.it